



10A



80A



300A

RoHS Directive compatibility information
<http://www.nais-e.com/>

FEATURES

1. High-voltage, high-current control capable

400 V DC high-voltage switching cutoff has been achieved thanks to a sealed construction with mixed hydrogen gas and magnetic arc motion through use of a permanent magnet.

2. Compact & Low Operating Sound

By using a capsule contact mechanism that is enclosed with hydrogen gas, high-capacity cutoff is possible even with a tiny contact gap. There is little operating sound, which does not change even when large currents are cut off.

3. Arc space unnecessary

The enclosure box can be made smaller thanks to an arc-space-free construction in which the arc will not get out.

4. Safety

Since the contacts are enclosed in a sealed capsule structure, the arc will not get out, which ensures safety.

5. High contact reliability

The contact part is hermetically sealed with H₂ mixed gas, hence the contact resistance remains stable regardless of the ambient conditions.

6. Mounting direction is not specified

The weight of the movable parts is light, and also the restoring force is large, hence the relay is relatively unaffected by gravity.

7. Coil voltage 24V DC type is also available

TYPICAL APPLICATIONS

- Electric Vehicle
- Hybrid Electric Vehicle
- Fuel-cell vehicle
- Construction machinery
- AGV (Automatic guided vehicle) (Unmanned transport carts)
- Battery inspection and testing equipment (charge and discharge control)

SPECIFICATIONS

Contact

Type		10A type	80A type	300A type
Arrangement		1 Form A	1 Form A	1 Form A
Rating	Nominal switching capacity (resistive load)	10A 400V DC	80A 400V DC	300A 400V DC
	Short term current	15A (2min), 30A (30sec)(2mm ²)	120A (15min)(15mm ²)	400A (10min)(100mm ²)
	Min. switching capacity #1	1A 12V DC	—	—
	Max. cut-off current	—	800A 300V DC (1 cycles) ^{#3}	2,500A 300V DC (3 cycles) ^{#2}
	Overload opening/closing rating	30A 400V DC (50 cycles) ^{#3}	120A 400V DC (50 cycles) ^{#3}	600A 400V DC (300 cycles)
	Reverse direction cut-off	-10A 200V DC (2.5×10 ⁴ cycles) ^{#3}	-120A 200V DC (50 cycles) ^{#3}	-300A 200V DC (100 cycles)
	Contact voltage drop	Max. 0.5V (When current is 10A per 1 contact set)	Max. 0.067V (When current is 20A per 1 contact set)	Max. 0.06V (When current is 300A per 1 contact set)
Expected life (min. operations)	Mechanical	10 ⁵	2×10 ⁵	2×10 ⁵
	Electrical	10A 400V DC 7.5×10 ⁴ (L/R ≤ 1ms) ^{#2}	80A 400V DC 10 ³ (L/R ≤ 1ms) ^{#2}	300A 400V DC 10 ³ (L/R ≤ 1ms)

Notes

#1 This value can change due to the switching frequency, environmental conditions, and desired reliability level, therefore it is recommended to check this with the actual load.

#2 Condition: Nominal switching 10 cycles, each cut off 2,500 A.

#3 The electrical load performance value for the 10A and 80 A types applies when a varistor is connected in parallel to the coil. Please be warned that working life will be reduced when a diode is used.

#4 The coil voltage 12 V DC type and 24 V DC type have the same specifications.

EV (AEV)

Characteristics

Initial insulation resistance		Min. 100MΩ (at 500 V DC) ^{*1}
Initial breakdown voltage	Between open contacts	AC 2,500 Vrms for 1min. ^{*2}
	Between contact and coil	AC 2,500 Vrms for 1min. ^{*2}
Operate time (at 20°C 68°F)		For 10A type: Max. 50ms ^{*3} For 80A type: Max. 50ms ^{*3} For 300A type: Max. 30ms ^{*3}
Release time (without diode) (at 20°C 68°F)		For 10A type: Max. 30ms ^{*4} For 80A type: Max. 30ms ^{*4} For 300A type: Max. 10ms ^{*4}
Shock resistance	Functional	For 10A type: Min. 196m/s ² {20 G} ^{*5} For 80A, 300A type (ON): Min. 196m/s ² {20 G} ^{*5} For 80A, 300A type (OFF): Min. 98m/s ² {10 G} ^{*5}
	Destructive	Min. 490 m/s ² {50 G} ^{*6}
Vibration resistance	Functional	For 10A, 80A type: 10 Hz to 200 Hz, Min.43 m/s ² {4.4 G} ^{*7} For 300A type: 10 Hz to 200 Hz, Min.44 m/s ² {4.5 G} ^{*7}
	Destructive	For 10A, 80A type: 10 Hz to 200 Hz, Min.43 m/s ² {4.4 G} ^{*8} For 300A type: 10 Hz to 200 Hz, Min.44 m/s ² {4.5 G} ^{*8}
Conditions for operation, transport and storage (Not freezing and condensing at low temperature)	Ambient temperature	For 10A, 80A type: -40°C to +80°C -40 to +176°F ^{*9} For 300A type: -40°C to +85°C -40 to +185°F ^{*9}
	Humidity	5% R.H. to 85% R.H.
Mass		10A type: 80g 2.82 oz 80A type: 400g 14.11 oz 300A type: 750g 26.46 oz

Remarks

*1 Measurement at same location as "Initial breakdown voltage" section.

*2 Detection current: 10mA

*3 Excluding contact bounce time

*4 Nominal voltage applied to the coil.

*5 Half-wave pulse of sine wave: 11ms; detection time: 10ms

*6 Half-wave pulse of sine wave: 6ms

*7 Detection time: 10ms

*8 Time of vibration for each direction; X, Y, Z direction: 4 hours

*9 Storage: Max.85°C 185°F.

ORDERING INFORMATION

Ex. A EV 0

Product Name	Contact arrangement	Contact rating	Coil voltage	Coil terminal structure
EV	1: 1 Form A	1: 10 A 8: 80 A 9: 300 A	12: 12V DC 24: 24V DC	Nil: Connector (80 A, 300 A) 2: Plug-in (with terminal protection cover, 10 A)

PACKING QUANTITY

Types	Inner	Outer
10A 1 Form A	25pcs.	100pcs.
80A 1 Form A	1pc.	20pcs.
300A 1 Form A	1pc.	5pcs.

TYPES AND COIL DATA (at 20°C 68°F)

Type	Part No.	Coil voltage, V DC	Pick-up voltage, V DC	Drop-out voltage, V DC	Nominal coil current	Operating power, W (12V and 24V DC)	Max. allowable voltage, V DC
10A	AEV110122	12 V DC	Max. 9 V DC	Min. 1 V DC	0.013 A ±10%	Max. 1.4 W	16 V DC
80A	AEV18012			Min. 1 V DC	0.375 A ±10%	Max. 4.5 W	
300A	AEV19012			Min. 2 V DC	3.3 A ±10% (at peak)	Max. 40 W (Inrush, approx. 0.1 sec.) Max. 4 W (Stable)	
10A	AEV110242	24 V DC	Max. 18 V DC	Min. 2 V DC	0.052 A ±10%	Max. 1.4 W	32 V DC
80A	AEV18024			Min. 2 V DC	0.188 A ±10%	Max. 4.5 W	
300A	AEV19024			Min. 4 V DC	1.85 A ±10% (at peak)	Max. 45 W (Inrush, approx. 0.1 sec.) Max. 4 W (Stable)	

DIMENSIONS

1. 10A

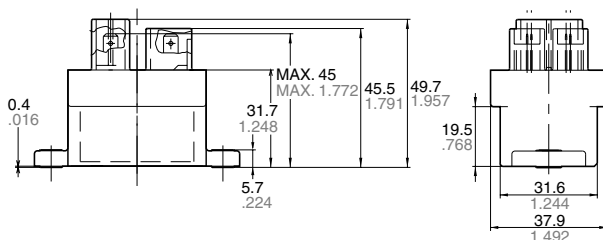
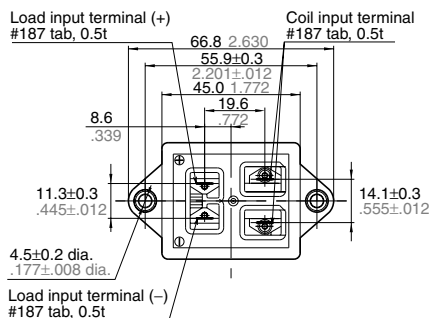

Schematic (TOP VIEW)

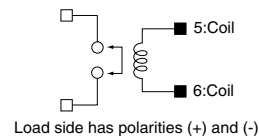

Mounting dimensions

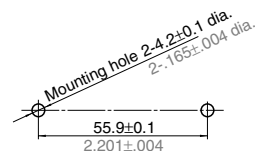

General tolerance:

- less than 10 (.394) ±0.3 (±.012)
- 10 (.394) to 50 (1.969) ±0.6 (±.024)
- more than 50 (1.969) ±1.0 (±.039)

2. 80A

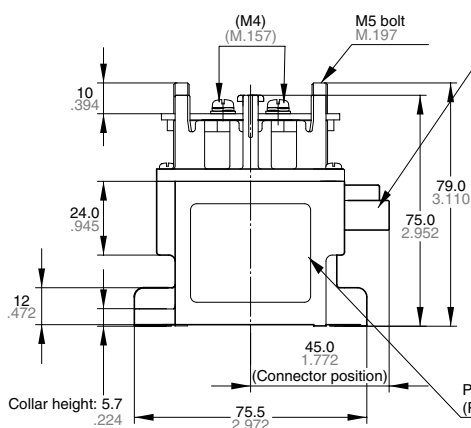
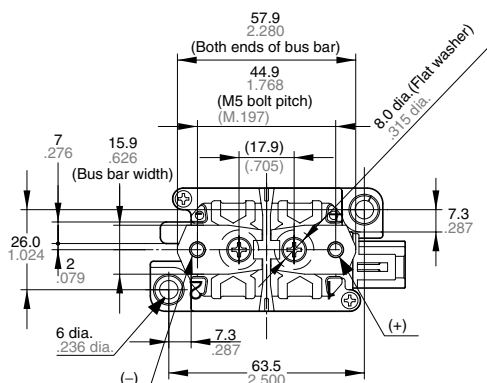

Polarity DC - Connector part number:
7282-1020 (Yazaki)

(Supplement) harness side
Female connector part number:
7283-1020

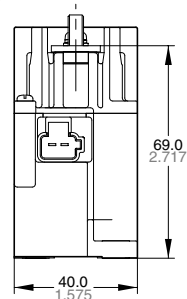

Schematic (TOP VIEW)

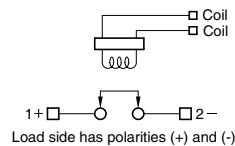

Mounting dimensions

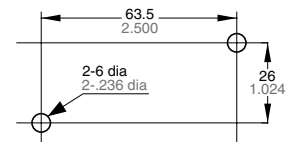

General tolerance:

- less than 10 (.394) ±0.3 (±.012)
- 10 (.394) to 50 (1.969) ±0.6 (±.024)
- more than 50 (1.969) ±1.0 (±.039)

EV (AEV)

3. 300A

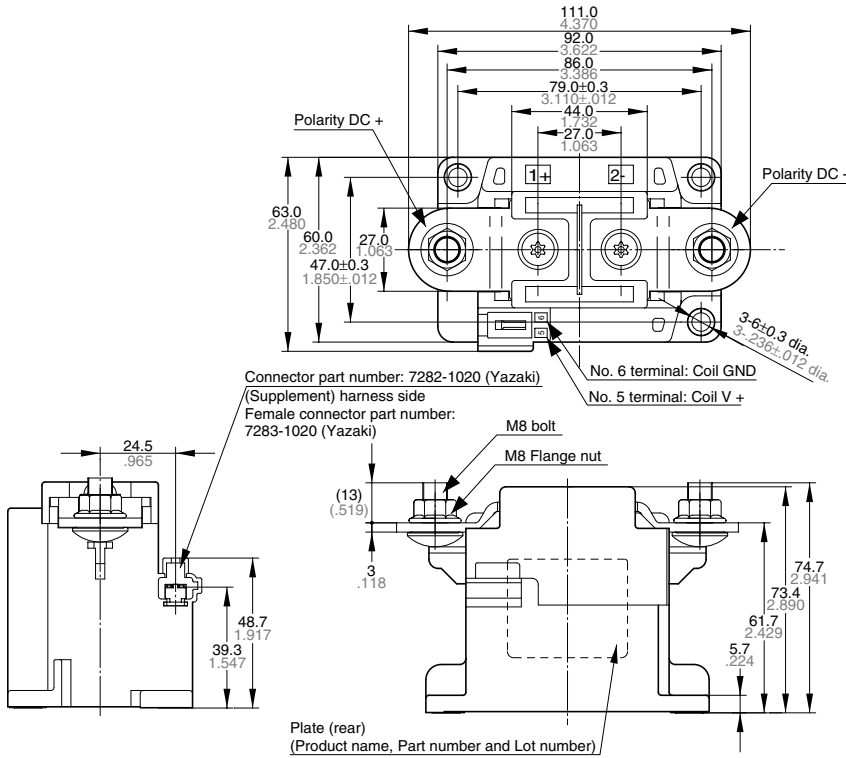

Schematic (TOP VIEW)

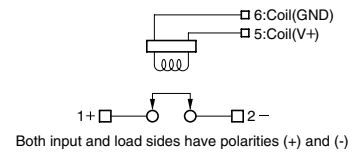

Mounting dimensions

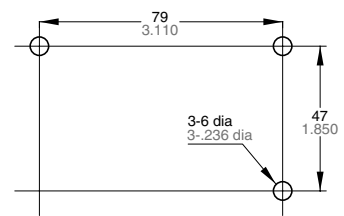

General tolerance:

less than 10 (.394) ±0.3 (±0.012)
 10 (.394) to 50 (1.969) ±0.6 (±0.024)
 more than 50 (1.969) ±1.0 (±0.039)

REFERENCE DATA

1-(1) Ambient temperature characteristics (10 A)

Sample: EV relay 10 A, 3 pcs

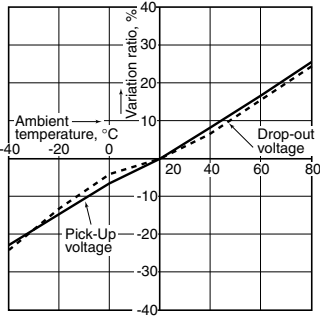

1-(2) Ambient temperature characteristics (80 A)

Sample: EV relay 80 A, 3 pcs

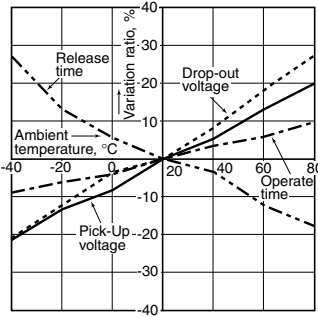

1-(3) Ambient temperature characteristics (300 A)

Sample: EV relay 300 A, 3 pcs

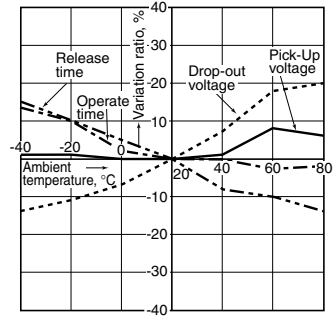

2. Max. value for switching capacity

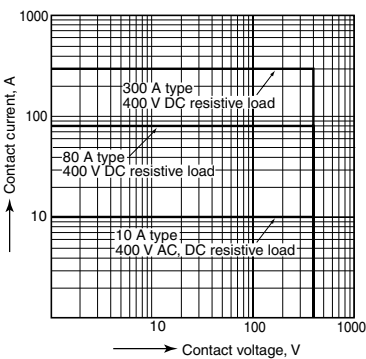

3. Switching life curve

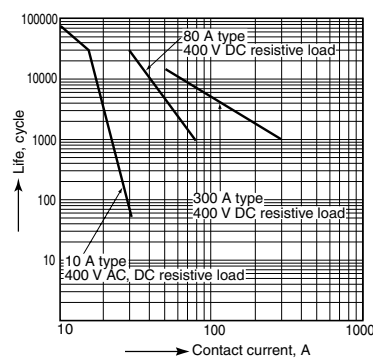

4. Cut-off life curve

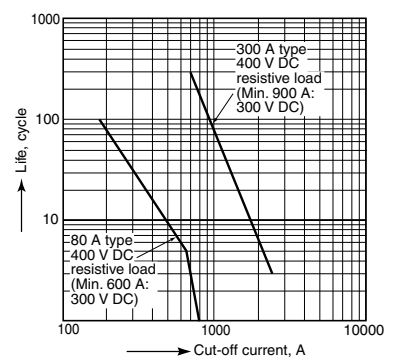

5. Carrying performance curve (80°C 176°F)

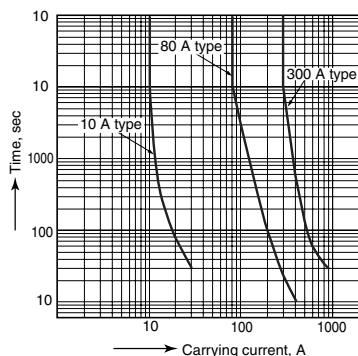

NOTES

1. When installing the relay, always use washers to prevent the screws from loosening.

Tighten each screw within the rated range given below. Exceeding the maximum torque may result in breakage. Mounting is possible in either direction.

- M4 screw (10 A): 1.8 to 2.7 N·m
- M5 screw (80 A, 300 A): 3 to 4 N·m
- M8 nut (300 A type): 10 to 12 N·m

2. The coils (300 A type) and contacts (all type) of the relay are polarized, so follow the connection schematic when connecting the coils and contacts.

Type 300 A contains a reverse surge voltage absorption circuit; therefore a surge protector is not needed. We recommend installing a surge protector varistor (ZNR) for the 10 A, 80 A types. Avoid using a diode as this may result in decreased cut-off capability.

3. As a general rule, do not use a relay if it has been dropped.**4. Avoid mounting the relay in strong magnetic fields (near a transformer or magnet) or close to an object that radiates heat.****5. Electrical life**

This relay is a high-voltage direct-current switch. In its final breakdown mode, it may lose the ability to provide the proper cut-off. Therefore, do not exceed the indicated switching capacity and life. (Please treat the relay as a product with limited life and replace it when necessary.)

In the event that the relay loses cut-off ability, there is a possibility that burning may spread to surrounding parts, so configure the layout so that the power is turned off within one second.

6. Permeation life of internal gas

This relay uses a hermetically encased contact (capsule contact) with gas inside. The gas has a permeation life that is affected by the temperature inside the capsule contact (ambient temperature + temperature rise due to flow of electrical current). For this reason, make sure the ambient operating temperature is between -40 and 80°C -40 and $+176^{\circ}\text{F}$ (300A type is Max. 85°C 185°F), and the ambient storage temperature is between -40 and 85°C -40 and $+185^{\circ}\text{F}$.

7. If the power is turned off and then immediately on after applying the rated voltage (current) continuously to the relay's coil and contact, the resistance of the coil will increase due to a rise in the coil temperature.

This causes the pick-up voltage to rise, and possibly exceed the rated pick-up voltage. In these circumstances, take measures such as reducing the load current, limiting the duration of current flow, and applying a coil voltage higher than the rated operating voltage.

8. Main contact ratings in the ratings apply to when there is a resistive load. If you are using an inductive load (L load) such that $L/R > 1$ ms, add surge protection in parallel with the inductive load.

If this is not done, the electrical life will decrease and cut-off failure may occur.

9. For the 300 A type, drive the coil with a quick startup. (Built-in one-shot pulse generator circuit)**10. Be careful that foreign matter and oils and fats kind don't stick to the main terminal parts because it is likely to cause terminal parts to give off unusual heat.**

Also, please use the following materials for connected harnesses and bus bars.

10 A type: Min. 2 mm^2 nominal cross-sectional area

80 A type: Min. 15 mm^2 nominal cross-sectional area

300 A type: Min. 100 mm^2 nominal cross-sectional area

11. As a guide, the insertion strength of the plug-in terminal into the 10 A type relay tab terminal should be 40 to 70 N. Please select a plug-in terminal (flat connection terminal) for #187 tab terminals that have a plate thickness of 0.5 and which comply with JIS C2809-1992.**12. Avoid excessive load applied to the terminal in case of installing such as a bus bar etc., Because it might adversely affect the opening and closing performance.****13. Use the specified connector for the connector terminal connection (80 A and 300 A)**

Yazaki Corporation 7283 – 1020 or equivalent

14. After the ON signal enters the 300A type, automatic coil current switching occurs after approximately 0.1 seconds. Do not repeatedly turn it OFF within that 0.1 seconds interval, as doing so may damage the relay.